



REVISED - - - ATM72 Auto Transfer Module

Genset Controls - Timers - Monitors - Trips - Battery Charging - Spares & Accessories - Custom Products

Effective November 1st 1998

This design has been revised to include the following ---



(1) Insulated Back

The internal construction of one full-length printed circuit board (Pcb) and one rear Pcb has been replaced with an insulated back and two full-length printed circuit boards. One Pcb each for the DC and AC circuits, thus improving 'DC' to 'AC' isolation.

Please note – the connectors are now Pcb mounted and are therefore in the vertical plane.

(2) Adjustable 'Mains Available' threshold (not ATM72D)

85 – 220VAC (300V absolute max.) for 220/240V systems ... pre-set at 180V unless specified otherwise.

30 -- 99VAC for 110/120V systems ... specify with order.

Set to minimum if external Phase monitoring used.

(3) Adjustable 'Alternator Available' threshold

85 – 220VAC (300V absolute max.) for 220/240V systems... pre-set at 180V unless specified otherwise.

30 -- 99VAC for 110/120V systems... specify with order.

Set to minimum if external Phase monitoring used.

(4) 'Delay' between contactor operations.

A nominal 2-second delay has been added to ensure a dwell time between one contactor opening and the other closing.

Please specify with order for other delays (max of 10 seconds).



(5) Separate Mains & Standby control relays

This allows delay between contactor change-over (see above), improves AC 'Mains' to 'Standby' isolation and increases relay contact ratings from 5Amp (resistive) to 16Amp (resistive).

Note: For Inductive Loads, the (resistive) rating must be de-rated to 14%. That is, 16Amps (resistive) = 2.2Amps continuous into an Inductive Load to ensure that Inrush currents do not exceed the contact rating.

(6) Transient Protection

A 'Transorb' device has been fitted to improve (DC) transient protection.

Intentionally Left Blank

ATM72 Auto Transfer Module

Genset Controls - Timers - Monitors - Trips - Battery Charging - Spares & Accessories - Custom Products

The ATM72 Auto-Transfer-Module is typically employed with the RSM72 Remote Start Module to provide an economical yet highly versatile AMF system. However, it can also operate as a 'stand-alone' module to upgrade existing 'Remote Start' systems.

Set in a compact 72mm sq DIN standard module this 'Auto Transfer Switch' can provide - (single phase) AC voltage monitoring of both the Mains supply and the Alternator together with a contactor control relay and three 'user adjustable' timers for Start Delay, Run On (on Load) and Stop Delay timing.

The front panel has up to five 'High Intensity' LED's to indicate system status.



Typical AMF Operation

With DC power connected, 'Mains Available' and 'Mains on Load' Led's lit, the ATM72 is in 'Standby' mode. If the Mains input falls below the pre-set threshold for the duration of (T3) the **'Start Delay'** timer, the Run relay will energise and latch, signalling for the Genset to start. As the Genset runs upto speed and the Alternator AC voltage rises above its pre-set threshold, the 'Alternator Available' Led lights and approx. 3sec's later the Standby Contactor energises. The load will now continue to be supplied from the Alternator until such time as the Mains Supply returns.

If a fault condition occurs (i.e. 'Low Oil Pressure'), the Remote Start Module will Shut-down the Engine and signal this 'Alarm' state to the ATM72 via the 'Interlock' on Term.27. This holds the Run Relay energised (to maintain DC power to the Remote Start Module) and de-energises the COR relay, dropping the Standby Contactor and thus preventing the Alternator from running down into the load !

Alternatively, if the Mains Supply returns in the normal way to a level above the pre-set threshold for the duration of (T4) the **'Run-On (on Load) Delay'** timer, the COR relay will de-energise, dropping the Standby Contactor and returning the Load to the Mains. Provided that the Mains Supply remains healthy for the duration of (T5) the **'Stop Delay'** timer, the Run Relay will de-energise (signalling for the Genset to Stop) and the ATM72 will return to its 'Standby Mode'.







If on the other hand, the Mains supply were to fail again during the 'Stop Delay' period, the Load would be immediately transferred back to the Alternator and the Stop Timer (T5), reset.

To guarantee that the Mains Contactor only energises and de-energises within specified voltage limits, an external Phase Failure Monitor may be required. Likewise, if the Alternator is to supply the Load to close tolerances on voltage &/or frequency, further monitoring may be needed.

The 'Manual' input can power the Module. It also sets the Run relay so that in the event of a 'Mains Failure' occurring during Manual Off-Load running, the Standby Contactor can energise as quickly as possible without waiting for the 'Start Delay' timer to elapse.

‘TYPICAL’ CONNECTIONS

Always ensure that the correct wire sizes are used and that all terminals are tightened correctly.

Terminal	Description	Input / Output	Connect To -----
21 B+	+Ve Supply	Input	RSM72, Term.17 (Auto Mode +Ve O/P)
22 B-	- Ve Supply	Input	Battery -Ve
23 	Run Relay N/C contact	Volt Free Contact	(not normally used)
24 	Run Relay C/O contact	Volt Free Contact	RSM72, Term.17 (Auto +Ve O/P)
25 	Run Relay N/O contact	Volt Free Contact	RSM72, Term.18 (Run, +Ve I/P)
26 MANUAL	Manual Input	+Ve Input	RSM72, Term.11 (Manual, +Ve O/P)
27 INT	‘Interlock’	- Ve Input	RSM72, Term.14 (Alarm O/P)
28 Lamp Test	+Ve Lamp Test Supply	+Ve Input	Common ‘Lamp Test’ circuit
29 Alt. On Load	Alternator On Load Status	- Ve Input	Standby Contactor (n/o ‘Aux.’ contacts)
30 Mains on Load	Alternator On Load Status	- Ve Input	Mains Contactor (n/o ‘Aux.’ contacts)
31 (See Text)	‘Mains’ Voltage Sensing	Input	(See Text)
32 (See Text)	‘Mains’ Voltage Sensing	Input	(See Text)
33 	COR Change-over Relay	N/C Contacts	(See Text)
34 		N/C Contacts	Mains Contactor Coil
35 		N/O Contacts	Standby Contactor Coil
36 		N/O Contacts	(See Text)
37 ALT. (L)	Alternator Voltage Sensing	A.C. Input	Main Alternator (270VAC max)
38 ALT. (N)	Alternator Voltage Sensing	A.C. Input	Main Alternator

Standard Build Options

ATM72AThe ‘A’ version senses a single phase AC voltage on Term.31 & 32 to detect a ‘Mains Failure’ condition. Typically used - - in AMF systems, with or without an external Phase Failure Monitor.

ATM72DThe ‘D’ version senses the Loss of a DC voltage on Term.31 (Term.32 not used) as a ‘Mains Failure’ or ‘Start’ condition. Typically used - - where greater versatility is needed, in Multi-Set systems and special builds.

BEWARE - Units with ‘A’, ‘D’ &/or ‘V’ options may not be interchangeable !

ATM72_V...The ‘V’ = volt-free (COR) contacts (Term.32 / 33 & 36 / 37 are **not** connected internally) Typically used - - where the COR relay is required to switch DC ‘slave’ relay(s).

Please refer to our latest ‘Catalogue & Price List’ to select the models to suit your ‘Specific’ applications.

WARNING - - WARNING - - WARNING - - WARNING - - WARNING

Voltages **dangerous to human life** may be present at some of the terminal connections of this unit. Ensure all supplies are Isolated before attempting any connection / disconnection.

ATM72 'Upgrade to AMF'

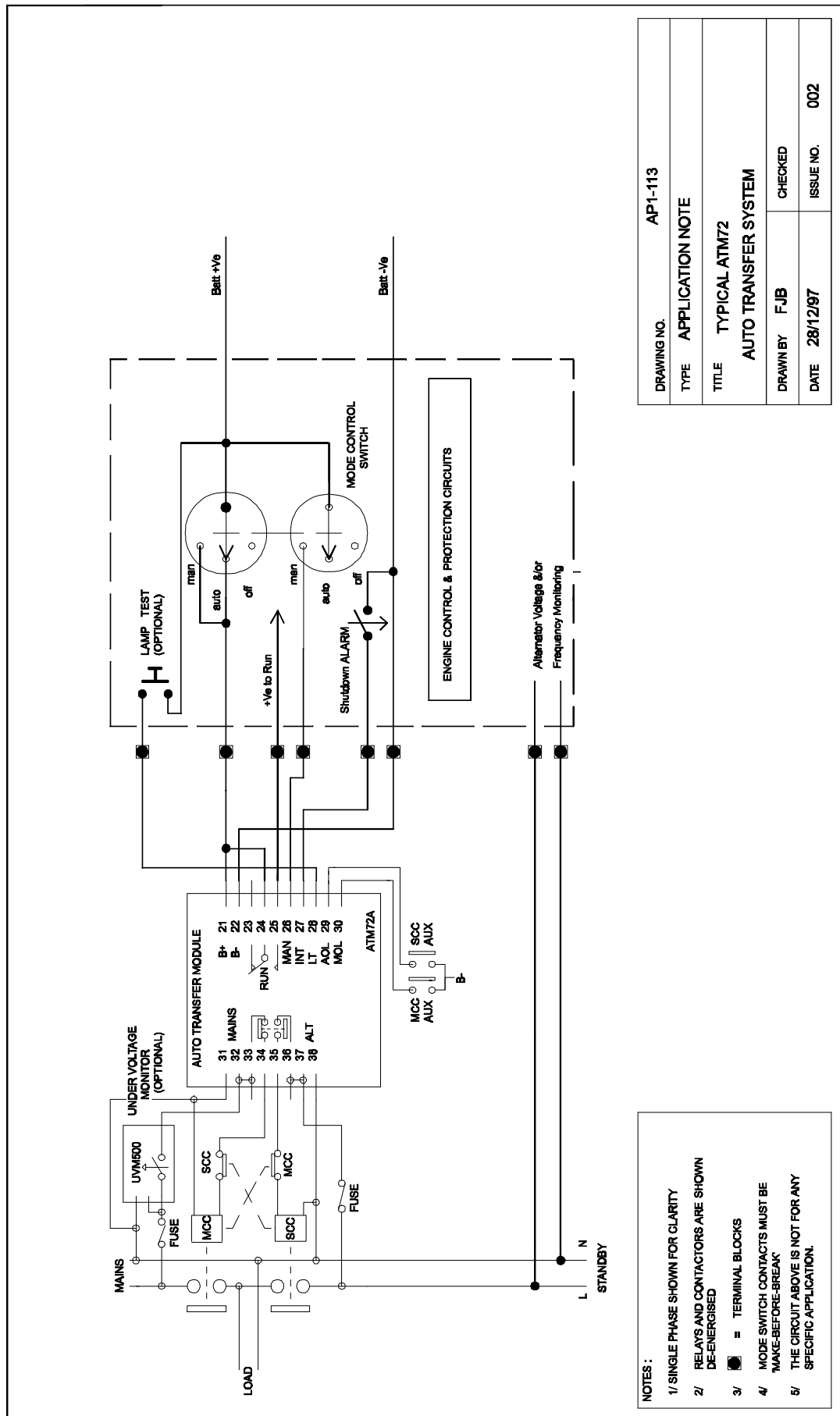

DRAWING NO.	AP1-113	TYPE	APPLICATION NOTE
TITLE	TYPICAL ATM72 AUTO TRANSFER SYSTEM		
DRAWN BY	FJB	CHECKED	
DATE	28/12/97	ISSUE NO.	002

- NOTES :**
- 1/ SINGLE PHASE SHOWN FOR CLARITY
 - 2/ RELAYS AND CONTACTORS ARE SHOWN DE-ENERGISED
 - 3/ = TERMINAL BLOCKS
 - 4/ MODE SWITCH CONTACTS MUST BE MAKE-BEFORE-BREAK
 - 5/ THE CIRCUIT ABOVE IS NOT FOR ANY SPECIFIC APPLICATION.

RSM72KWX + ATM72D = Mains Failure System

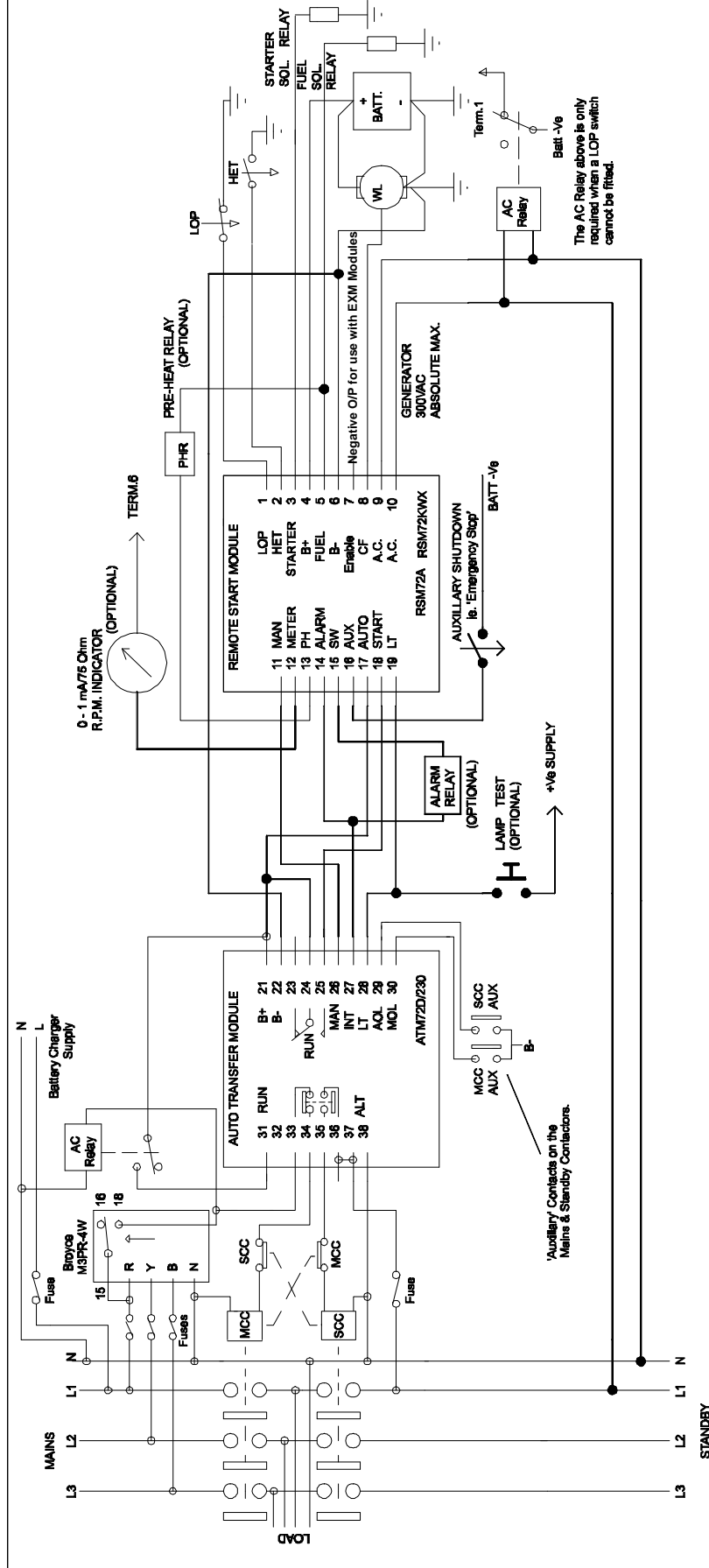

DRAWING NO.	AN97006
TYPE	APPLICATION NOTE
TITLE	RSM72AWX + ATM72D TYPICAL A.M.F. SYSTEM for 3PH 4W 230/415V
DRAWN BY	F.W.O
CHECKED	CHECKED
DATE	28/12/97
ISSUE NO.	002

NOTES:

- 1/ A.C. & D.C. SUPPLIES DE-ENERGISED
- 2/ RELAYS AND CONTACTORS ARE SHOWN DE-ENERGISED
- 3/ THIS WIRING DIAGRAM IS FOR GUIDANCE ONLY. IT IS NOT DESIGNED TO MEET ANY SPECIFIC APPLICATION.



FAULT FINDING ----- ATM72 BASED SYSTEMS

Always check the 'obvious' first i.e. :

- ◆ System correctly wired
- ◆ Correct ATM72 type fitted
- ◆ Timers T3, T4 and T5 set to suit the specific application
- ◆ All connections use suitably rated cables to comply with all appropriate regulations.
- ◆ All terminal screw connections are tight.
- ◆ Battery(s) are charged, in good condition, with clean & tight connections and of the correct voltage

WARNING - Incorrect wiring can permanently damage the module i.e. -

- 1/ **Loss of battery negative (Term.22) or a loose connection**
- 2/ **Connecting any 'Active low' outputs (i.e. INT) directly to a positive supply.**
- 3/ **Connecting any DC terminals to an AC supply.**

- **Unit Dead - set will not start**

Check for a positive supply on term.21(B+) or term.26 (Manual) and a negative supply on term.22 (B-) of the ATM72 using a DC voltmeter or by shorting term.21 &/or term.26 to term.19 (lamp test) and observing if the Led's all light.

- **Mains on Load - but the status Led not lit**

Term.30 must connect to Battery -Ve via n/o auxiliary contacts on the mains contactor.

- **Mains failed but Genset does not start**

Engine control module (i.e. RSM72) switched 'Off'.

Terminals 24 or 25 are disconnected by external circuitry (intentionally or otherwise)

- **Mains failed, Genset starts but will not take the load**

'Alternator Available' Led NOT lit - Alternator voltage below threshold of ATM72 (typically 180V on 230V system)

- Alternator voltage not connected to terminals 37 & 38 (i.e. Blown fuse)

'Alternator Available' Led lit - Incorrect wiring to the contactors

- Term. 27 (INT) connected to Battery -Ve

- **Genset on load - but the status Led not lit**

Term.29 must connect to Battery -Ve via n/o auxiliary contacts on the alternator contactor.

- **Mains returns but the load is not transferred back**

'Mains Available' Led NOT lit - Mains voltage below threshold of ATM72 (typically 180V on 230V system)

- Mains voltage not connected to terminals 31 & 32 (i.e. Blown fuse)

'Mains Available' Led lit - T4 the 'Run on' (on load) timer (typically 30s - 30m) is set to high

- The mains is not stable for this period.

- **Mains returns and load is transferred back but the Genset will not stop**

Engine control module (i.e. RSM72) switched to MANual

Terminals 24 & 25 connected by external circuitry (intentionally or otherwise)

SPECIFICATION

DC Supply : 12/24V Single range supply. < 4V Dropout / 40V Absolute Maximum.
Burden = 25mA Standby, 100mA Maximum.

Mains Sensing : 10 - 300VAC (absolute maximum) Single Phase. No hysteresis.

Threshold = 180V (for 220/240V systems) & 90V (for 1100/120V systems) or as specified.

Alternator Sensing : 10 - 300VAC (absolute maximum) Single Phase. No hysteresis.

Threshold = 180V (for 220/240V systems) & 90V (for 1100/120V systems) or as specified.

Relay Contacts : RUN Relay = SPCO rated at 16A / 60VDC (Resistive Load)
COR Relay = DPCO rated at 5A / 230VAC (Resistive Load)

Timers :

T3 Start Delay	0.5 - 30 sec User Adjustable	(unless specified otherwise)
Warm-up Delay	Fixed 3 sec	(unless specified otherwise)
T4 Run-On Delay	30s - 30 min User Adjustable	(unless specified otherwise)
T5 Stop Delay	4s - 4 min User Adjustable	(unless specified otherwise)

General : Ambient temperature -10⁰C to +55⁰C Operating, -25⁰C to +70⁰C Storage

Protection : 'Varistor' devices are fitted (internally) across each contact set of the changeover relay (COR) to minimise arcing and hence prolong the contact life. They are also fitted at the 'Mains' and 'Alternator' terminals to protect the sensing circuitry.

Construction : Through panel fitting, 72mm sq. DIN standard case. Reversed screen printed "LEXAN" front panel. Printed Circuit Boards, varnished as standard.

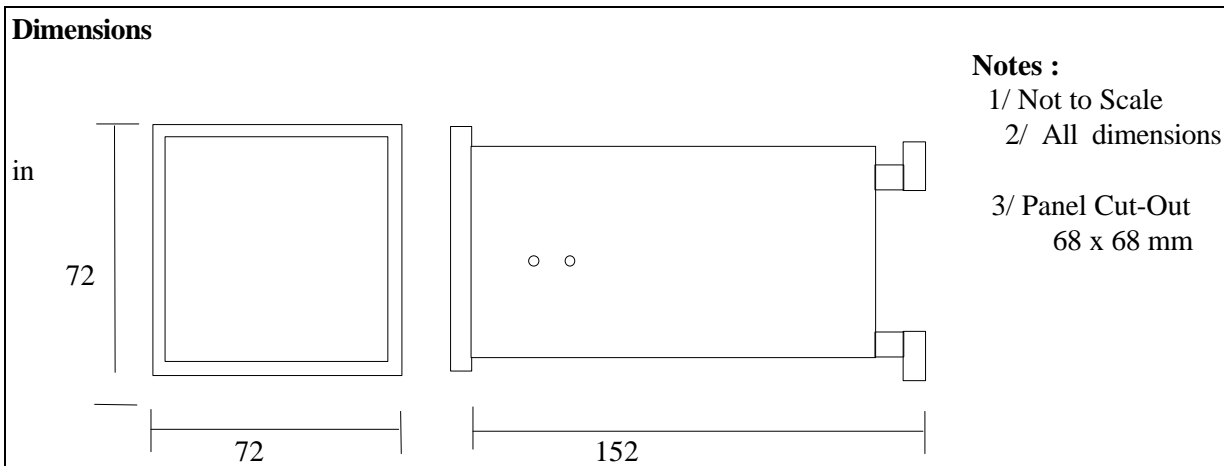

MOUNTING

The module must be fitted into a suitable control panel which provides adequate protection from the extremes of : Temperature, Humidity & Vibration. If this control panel is set-mounted then suitable 'Anti-Vibration' mounts **MUST** be used

Note : If specific information &/or a replacement unit is required, please ensure that the 'Serial Number' of the original unit is always quoted.



CAPRICORN CONTROLS LIMITED

INDUSTRIAL ELECTRONIC ENGINEERS

SPECIALIST CONTROLS FOR ENGINE APPLICATIONS

Thorpe Close, Banbury, Oxon., OX16 4SW. England

Tel: +44 (0) 1295 272360 Fax: +44 (0) 1295 264766

E-mail: sales@capricorn-controls.com Web: www.capricorn-controls.com

Keystart, Remote Start, Start-on-Demand, Mains Failure, Mutual Standby & Multi-set Controllers.
Annunciators and Lamp Modules. Voltage, Current, Frequency, Speed, and Temperature Monitors.
Timers. Transport Refrigeration Spares. Batteries, Battery Chargers and Power Supplies. Spares and
Accessories. Customised Products and Bespoke Designs.